

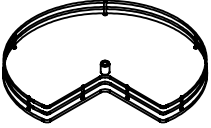



Component list

| | | |
|--|--|--|
| <p>A 2 pcs</p>  | <p>B 1 pc</p>  | <p>C 2 pcs</p>  |
| <p>D 1 pc</p>  | <p>E 1 pc</p>  | <p>F 2 pcs</p>  |
| <p>G 2 pcs</p>  | <p>H 8 pcs</p>  <p>ST4*14</p> | |

Dimensions (mm)

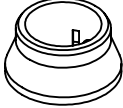
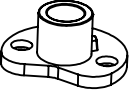
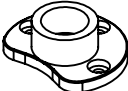
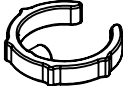
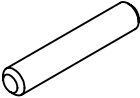
| Cabinet size | Depth (D) | Width (W) | Height (H) | Front edge distance (X) |
|--------------|-----------|-----------|------------|-------------------------|
| 900 | ≥500 | 900 | 800≥H≥600 | 120 |

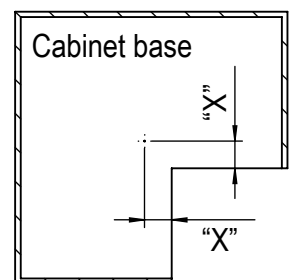
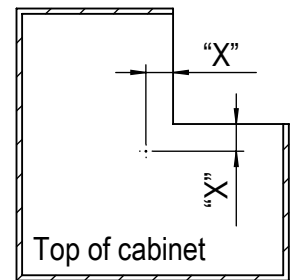
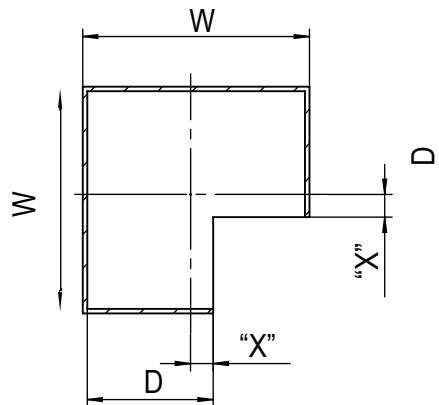
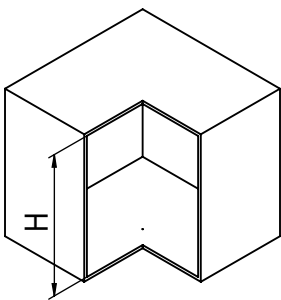

Installation

- 1) Mark out two parallel lines with distance X from front edge of cabinet
- 2) Fit parts D and E with H at the intersection of the two lines

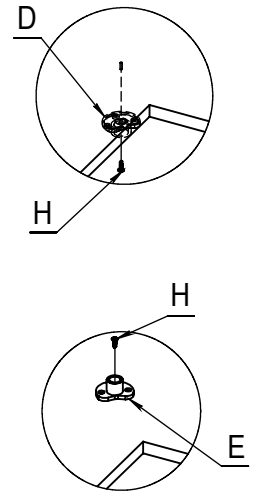
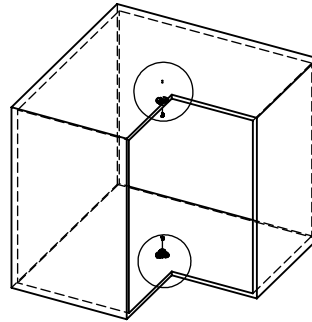

- 3) Assemble parts A, B, C, F, G to complete carousel

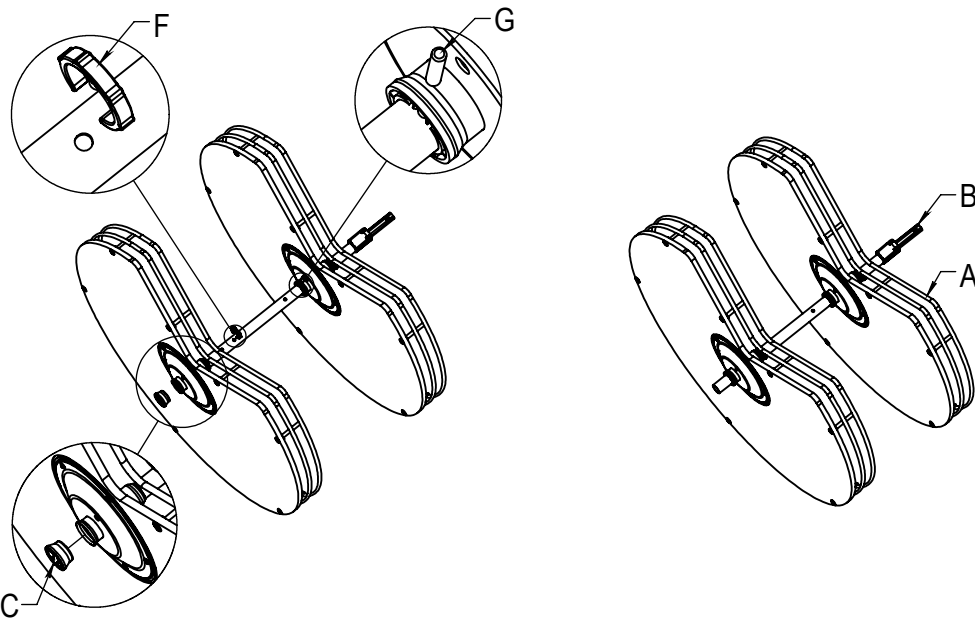

- 4) Lock assembly into D and E to complete installation

