



# CABINET HARDWARE SYSTEMS

## KITCHEN STORAGE

# #KTC

### Australia

1800 008 591 ■ [www.artia.com.au](http://www.artia.com.au)

**VICTORIA:**

235 Settlement Road,  
Thomastown VIC 3074

**NEW SOUTH WALES:**

Unit 1/429 Victoria Street,  
Wetherill Park NSW 2164

**QUEENSLAND:**

Building 2/660 MacArthur  
Avenue, Pinkenba QLD 4008

**SOUTH AUSTRALIA:**

13 Rosberg Road,  
Wingfield SA 5013

**WESTERN AUSTRALIA:**

Unit 1B/15 Hector Street,  
Osborne Park WA 6017

### New Zealand

0800 267 625 ■ [www.artia.co.nz](http://www.artia.co.nz)

**AUCKLAND:**

11 Bruce Roderick Drive,  
East Tamaki, Auckland 2013

**CHRISTCHURCH:**

117 Wrights Road,  
Addington, Christchurch 8024

# KITCHEN STORAGE

## CONTENTS

▪ <b>Sige Pull Out Pantry Units</b> .....	<b>04</b>
▪ Sige Pull Out Pantry Basket .....	04
▪ Sige Pull Out Pantry Frame .....	04
▪ Sige Pull Out Pantry Slide Kit .....	04
▪ Sige Tandem Pull Out .....	05
▪ Sige Pull Out Shelf / Basket .....	05
▪ Sige Side-Mount Pull Out – 2 Basket .....	06
▪ Sige Bottom-Mount Pull Out – 2 Basket .....	06
▪ Sige Bottle Rack Kit .....	06
▪ Sige Pull Out Swing Corner Shelf .....	07
▪ <b>Sige Pull Out Corner Units</b> .....	<b>07</b>
▪ Sige Pull Out Corner Unit .....	07
▪ <b>Sige Pull Out Pantry Units</b> .....	<b>08</b>
▪ Sige 3/4 Round Corner Carousel .....	08
▪ Sige Half Moon Corner Carousel .....	08
▪ <b>Sige Waste Organiser Solutions</b> .....	<b>09</b>
▪ Sige Pull Out Waste Organiser to Suit 300mm Cabinet .....	09
▪ Sige Pull Out Waste Organiser to Suit 400mm Cabinet .....	09
▪ Sige Pull Out Waste Organiser to Suit 450mm Cabinet .....	10
▪ Sige Pull Out Waste Organiser to Suit 500mm Cabinet .....	10
▪ Sige Pull Out Waste Organiser to Suit 600mm Cabinet .....	11
▪ Sige Pull Out Waste Organiser To Suit 400mm Cabinet .....	11
▪ Compact Bin For Insertion In 35 Litre Sige Bins .....	12
▪ <b>Sige Laundry Hamper</b> .....	<b>12</b>
▪ Sige Laundry Hamper .....	12
▪ <b>Artia Cabinet Hardware Systems Pull Out Pantry Units</b> .....	<b>13</b>
▪ Artia Cabinet Hardware Systems Pull Out Pantry .....	13
▪ <b>Artia Cabinet Hardware Systems Pull Out Cabinet Units</b> .....	<b>14</b>
▪ Artia Cabinet Hardware Systems Pull Out Organiser .....	14
▪ Artia Cabinet Hardware Systems Pull Out Rack .....	14
▪ <b>Artia Cabinet Hardware Systems Pull Out Corner Units</b> .....	<b>15</b>
▪ Artia Cabinet Hardware Systems Contour Unit .....	15
▪ <b>Artia Cabinet Hardware Systems Waste Organisers</b> .....	<b>16</b>
▪ Artia Cabinet Hardware Systems 2 x 20L Waste Organisers with Self-Close Runners .....	16
▪ Artia Cabinet Hardware Systems 2 x 15L Waste Organisers with Soft-Close Runners .....	16
▪ <b>Kimberley™ Cutlery Inserts</b> .....	<b>16</b>
▪ Kimberley™ Moulded Cutlery Inserts .....	16
▪ <b>Kimberley™ Pull Out Corner Units</b> .....	<b>17</b>
▪ Kimberley™ 270° Lazy Susan .....	17
▪ <b>Kimberley™ Waste Organiser Solutions</b> .....	<b>17</b>
▪ Kimberley™ 10L Automatic Waste Bin .....	17
▪ Kimberley™ 30L Twin Bin Waste Separation System (320mm Wide) .....	18
▪ Kimberley™ 30L Twin Bin Waste Separation System (350mm Wide) .....	18
▪ Kimberley™ 30L Twin Bin Waste Separation System (Door Mounted) .....	18
▪ <b>Technical Information</b> .....	<b>19</b>
▪ <b>Index</b> .....	<b>22</b>

# KITCHEN STORAGE



**Sige S.p.a. is a high-end Italian manufacturer of intelligent pantry storage and waste management solutions with a 50-year pedigree.**

Continuous and carefully considered investments in the maintenance and purchase of technical instruments and the latest generation of machines that are needed to increase the efficiency and quality of every production process, tie in with insights from regular market research which drives a continuous stream of product innovations.

First impressions count, and the Sige pantry solution convince with their high-quality appeal, and prove their worth with smooth running characteristics even when heavily loaded – time after time. Choose between individual pull-out shelves or complete pull-out pantries to help organising everything in your pantry, or make the most of blind corners in your kitchen with smart swing-out corner units.

At the other end of the cooking process, Sige waste management solutions keep kitchen waste under control, and with a choice of bin sizes and configuration, play their part in supporting the recycling requirements of your household.



# KITCHEN STORAGE

## SIGE PULL OUT PANTRY UNITS

### ► Sige Pull Out Pantry Slide Kit







- Full-extension soft-close slides
- 120kg load capacity
- Includes door brackets with 3D adjustment
- To suit 300mm, 400mm and 500mm pantry widths
- Made In Italy

Code <b>1</b>		W	D
<b>191430</b>	300	250	500
<b>191440</b>	400	350	500
<b>191450</b>	500	450	500

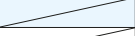

### ► Sige Pull Out Pantry Frame

- Pantry frame to suit pull-out pantry
- Height adjustable
- Made In Italy

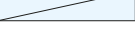
Code <b>2</b>		W	D	H
<b>191407</b>	300		500	1880-2180
	400		500	1880-2180
	500		500	1880-2180
<b>191406</b>	300		500	1615-1915
	400		500	1615-1915
	500		500	1615-1915



### ► Sige Pull Out Pantry Basket

- Basket to suit pull-out pantry unit
- Solid white melamine base
- Flat railing with high quality chrome-plating
- Available to suit 300mm, 400mm and 500mm pantry widths
- Made In Italy

Code <b>3</b>		W	D	H	Qty
<b>191530</b>	300	230	440	120	5
<b>191540</b>	400	330	440	120	5
<b>191550</b>	500	430	440	120	5

#### Additional Baskets

Code		W	D	H	Qty
<b>191530-1</b>	300	230	440	120	1
<b>191540-1</b>	400	330	440	120	1
<b>191550-1</b>	500	430	440	120	1

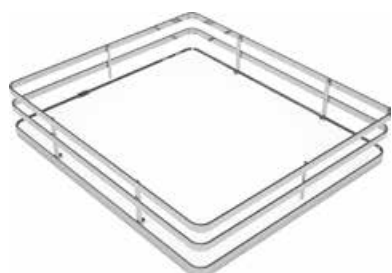

To complete a Sige pull-out pantry, order as follows:

- 1 x **1** (set)
- 1 x **2** (one frame)
- 1 x **3** (set of 5)



For technical information, please refer to the end of this catalogue section.

# KITCHEN STORAGE

## SIGE PULL OUT PANTRY UNITS

### ► Sige Tandem Pull Out

- Pull-out tandem dispenser
- Soft-opening and soft-closing
- 6 internal baskets with 6 door-mounted baskets
- Internal frame moves forward through door opening action
- 50kg load capacity
- Solid white melamine base
- Flat railing with high quality chrome-plating
- 1800mm high
- Reversible for left-hand or right-hand installation
- Suits 450mm or 600mm external cabinet width
- Made In Italy

Code	W	D	H	
191414#	450	410	470	1800
191415#	600	560	470	1800



For technical information, please refer to the end of this catalogue section.

### ► Sige Pull Out Shelf / Basket

- Pull-out shelf
- Grass full-extension 40kg soft-close drawer slides
- Solid white melamine base
- Flat railing with high quality chrome plating
- Suit 450mm or 600mm external cabinet width
- Made In Italy

Code	W	D	H	
191404	450	410-418	500	160
191405	600	560-568	500	160



For technical information, please refer to the end of this catalogue section.



# KITCHEN STORAGE

## SIGE PULL OUT PANTRY UNITS

### ► Sige Side-Mount Pull Out – 2 Baskets

- Side-mount pull-out organiser
- 2 baskets
- Grass full-extension 40kg soft-close drawer slides
- Left side mounting
- Solid white melamine base
- Flat railing with high quality chrome-plating
- Suits 150mm external cabinet width
- Door mounted
- Bottle rack dividers optional (191466)
- Made In Italy

Code	📏	W	D	H
<b>191401</b>	150	110	500	520



\* Bottle rack dividers optional (**191466**)



For technical information, please refer to the end of this catalogue section.

### ► Sige Bottom-Mount Pull Out – 2 Baskets

- Bottom-mount pull-out organiser
- 2 baskets
- Grass full-extension 40kg soft-close drawer slides
- Left side mounting
- Solid white melamine base
- Flat railing with high quality chrome-plating
- Suits 150mm external cabinet width
- Door mounted
- Bottle rack dividers optional (191466)
- Made In Italy

Code	📏	W	D	H
<b>191418</b>	300	260-268	500	520
<b>191419</b>	450	410-418	500	520



\* Bottle rack dividers optional (**191466**)



For technical information, please refer to the end of this catalogue section.

### ► Sige Bottle Rack Kit

- Divider rail with four insert clips to create bottle section

Code	Description
<b>191466</b>	Bottle rack kit for 300 - 450 - 600 basket.





# KITCHEN STORAGE

## SIGE PULL OUT PANTRY UNITS

### ► Sige Pull Out Swing Corner Shelf

- Pull-out shelves for corner cabinets
- Easy installation onto existing cabinet shelf
- Retrofittable
- 20kg load capacity per shelf
- Solid white melamine base
- 2 storage shelves
- Flat railing with high quality chrome-plating
- Reversible to suit left or right-hand opening
- To suit 900mm external cabinet width
- Made In Italy

Code	Installation	☐	W	D
<b>191412</b>	Left	900	450	500
<b>191413</b>	Right	900	450	500

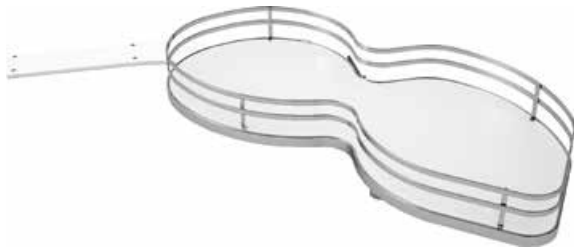

For technical information, please refer to the end of this catalogue section.

## SIGE PULL OUT CORNER UNITS

### ► Sige Pull Out Corner Unit

- Pull-out storage for corner cabinets
- Soft-opening and soft-closing
- 2 internal baskets with 2 door-mounted baskets
- Internal frame moves forward through door opening action
- 35kg load capacity (15kg front + 20kg back)
- Solid white melamine base
- Flat railing with high quality chrome-plating
- Available to suit left or right-hand opening
- To suit 900mm external cabinet width
- Made In Italy

Code	Installation	☐	W	D	H
<b>191408</b>	Left	Min. 900	860	500	600
<b>191409</b>	Right	Min. 900	860	500	600



Image shows Right Opening Unit  
For technical information, please refer to the end of this catalogue section.

# KITCHEN STORAGE

## SIGE PULL OUT PANTRY UNITS

### ► Sige 3/4 Round Corner Carousel

- 3/4 round carousel for corner cabinets
- 2 rotating shelves
- 20kg load capacity per shelf
- Solid white melamine base
- Flat railing with high quality chrome-plating
- To suit 900mm x 900mm external corner cabinet width
- Made In Italy

Code	📏	R
191416	900 x 900	810



### ► Sige Half Moon Corner Carousel

- Half moon carousel for corner cabinets
- 2 individually rotating shelves
- 15kg load capacity
- Solid white melamine base
- Flat railing with high quality chrome-plating
- To suit 800mm external cabinet width
- Made In Italy

Code	W	D	H
191417	760	390	510





# KITCHEN STORAGE

SIGE WASTE ORGANISER SOLUTIONS

## ► Sige Pull Out Waste Organiser to Suit 300mm Cabinet

- Door-mounted
- 1 x 35 litre bin
- Min internal cabinet width 268mm
- Min internal cabinet height 560mm
- Min internal cabinet depth 505mm
- Concealed Grass Nova Pro 40kg full extension soft-close slides
- Handles integrated into bin side for ease of extraction
- Adjustable door mount brackets
- Includes removable bin cover
- Made In Italy

Code	Icon	W	D	H	LT	
191301		300	260-268	505	560	35



## ► Sige Pull Out Waste Organiser to Suit 400mm Cabinet

- Door-mounted
- 1 x 35 litre bin
- Min internal cabinet width 368mm
- Min internal cabinet height 560mm
- Min internal cabinet depth 505mm
- Concealed Grass Nova Pro 40kg full extension soft-close slides
- Handles integrated into bin side for ease of extraction
- Adjustable door mount brackets
- Includes removable bin cover
- Made In Italy

Code	Icon	W	D	H	LT	
191303		400	360-368	505	560	35



# KITCHEN STORAGE

## SIGE WASTE ORGANISER SOLUTIONS

### ► Sige Pull Out Waste Organiser to Suit 450mm Cabinet

- Door-mounted
- 2 x 35 litre bins (total 70l)
- Min internal cabinet width 418mm
- Min internal cabinet height 560mm
- Min internal cabinet depth 505mm
- Concealed Grass Nova Pro 40kg full extension soft-close slides
- Handles integrated into bin side for ease of extraction
- Adjustable door mount brackets
- Includes removable bin cover
- Made In Italy

Code	Icon	W	D	H	LT	
191305		450	410-418	505	560	70



**BEST  
SELLER**

### ► Sige Pull Out Waste Organiser to Suit 500mm Cabinet

- Door-mounted
- 2 x 35 litre bins (total 70l)
- Min internal cabinet width 468mm
- Min internal cabinet height 560mm
- Min internal cabinet depth 505mm
- Concealed Grass Nova Pro 40kg full extension soft-close slides
- Handles integrated into bin side for ease of extraction
- Adjustable door mount brackets
- Includes removable bin cover
- Made In Italy

Code	Icon	W	D	H	LT	
191307		500	460-468	505	560	70



# KITCHEN STORAGE

SIGE WASTE ORGANISER SOLUTIONS

## ► Sige Pull Out Waste Organiser to Suit 600mm Cabinet

- Door-mounted
- 2 x 35 litre and 2 x 7.5 litre bins (total capacity 85l)
- Min internal cabinet width 568mm
- Min internal cabinet height 560mm
- Min internal cabinet depth 505mm
- Concealed Grass Nova Pro 40kg full extension soft-close slides
- Handles integrated into bin side for ease of extraction
- Adjustable door mount brackets
- Includes removable bin cover and lids for 7.5l bins
- Made In Italy

Code	Icon	W	D	H	LT	
191309		600	560-568	505	560	35



## ► Sige Pull Out Waste Organiser To Suit 400mm Cabinet

- Ideal for townhouses, apartments and 1-2 bedroom units
- 1 x 21 litre and 2 X 7.5 litre bins (total 36 litres) for household waste, recycling and green waste
- Min internal cabinet width 360-368mm
- Min internal cabinet height 380mm
- Min internal cabinet depth 505mm
- Concealed 40kg full extension Grass soft-close slides
- Handles integrated into bin side for ease of extraction and arresting bin liner
- Adjustable door mount brackets
- Includes removeable waster organiser cover shelf and two lids for the 7.5 litre bins for hygiene and odour control
- Made In Italy

Code	Icon	W	D	H	LT	
191317		400	360-368	505	380	36

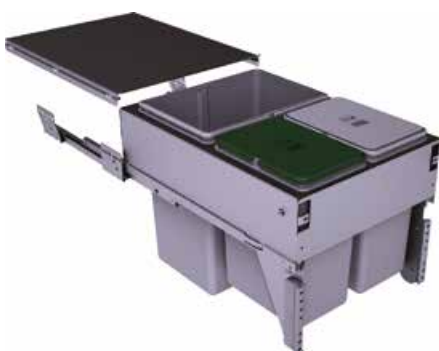

# KITCHEN STORAGE

## SIGE WASTE ORGANISER SOLUTIONS

### ► Compact Bin For Insertion In 35 Litre Sige Bins

- Intelligent solution to add separate waste space in 35 litre SIGE™ bins
- Suitable for 191301, 191303, 191305, 191307, 191309
- 1 x 5 litres, for the collection of green waste for example
- Includes lid for hygiene and odour control
- Made In Italy

Code	Icon	W	D	H	LT	
191305		450	410-418	505	560	70



Note: Sample installation of 191311 in 191305 (sold separately)

## SIGE LAUNDRY HAMPER

### ► Sige Laundry Hamper

- Exclusive to Artia Cabinet Hardware Systems
- 1 x 53 litre laundry hamper
- Side-mounted slides
- Grass soft-Close over-extension Slides
- Quality polypropylene bucket with air vents to the side and solid base, incl. lid
- Moulded lip around bin for easy removal
- Pitch & height adjustable door bracket
- Load capacity 40kg
- White
- Made in Italy

Code	Icon	W	D	H	
191505		450	410-418	505	590



For technical information, please refer to the end of this catalogue section.

# KITCHEN STORAGE

## ARTIA CABINET HARDWARE SYSTEMS PULL OUT PANTRY UNITS

### ► Artia Cabinet Hardware Systems Pull Out Pantry

- Pull Out pantry system for high storage units
- Full extension ball bearing slides
- 100kg load capacity
- Adjustable height frames
- Adjustable basket positions
- Self close action



Code	Description	Cabinet Height
<b>551.GZHN119U2C.340#</b>	Suits 300mm Cabinet Width 4 Baskets	1190mm - 1650mm
<b>551.GZHN168U2C.340</b>	Suits 300mm Cabinet Width 6 Baskets	1680mm - 2175mm
<b>551.GSG2B30D.340#</b>	Additional Basket to Suit 300mm	
<b>551.GZHN119U3C.340#</b>	Suits 400mm Cabinet Width 4 Baskets	1190mm - 1650mm
<b>551.GZHN168U3C.340</b>	Suits 400mm Cabinet Width 6 Baskets	1680mm - 2175mm
<b>551.GSG2B40D.340</b>	Additional Basket to Suit 400mm	

### Dimensions

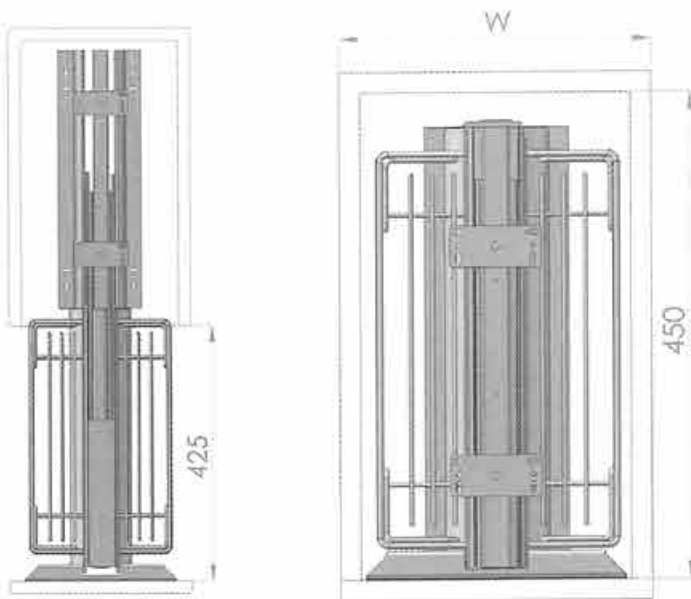



# KITCHEN STORAGE

## ARTIA CABINET HARDWARE SYSTEMS PULL OUT CABINET UNITS

### ▶ Artia Cabinet Hardware Systems Pull Out Organiser

- Full extension pull-out baskets
- Fitted with full extension ball bearing slides

Code	Description	Basket Dimensions
<b>551.OS4D4046.340</b>	400mm Cabinet Width	130 x 307 x 480
<b>551.OS4D4546.340</b>	450mm Cabinet Width	130 x 357 x 480
<b>551.OS4D5046.340</b>	500mm Cabinet Width	130 x 407 x 480
<b>551.OS4D6046.340</b>	600mm Cabinet Width	130 x 507 x 480
<b>551.OS4D7046.340</b>	700mm Cabinet Width	130 x 607 x 480
<b>551.OS4D8046.340</b>	800mm Cabinet Width	130 x 707 x 480
<b>551.OS4D9046.340</b>	900mm Cabinet Width	130 x 807 x 480
<b>551.OS4D1046.340#</b>	1000mm Cabinet Width	130 x 907 x 480

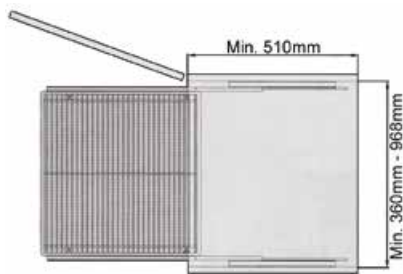

artia  
CABINET HARDWARE SYSTEMS

### ▶ Artia Cabinet Hardware Systems Pull Out Rack

- Bottom-mounted
- Ideal for installation under laundry tubs

Code	Basket Dimensions
<b>ADA-31345</b>	244 x 426 x 450

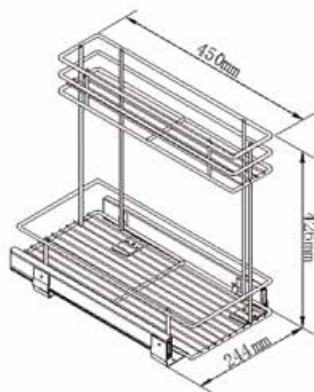

artia  
CABINET HARDWARE SYSTEMS

# KITCHEN STORAGE

## ARTIA CABINET HARDWARE SYSTEMS PULL OUT CORNER UNITS

### ▶ Artia Cabinet Hardware Systems Contour Unit

- Suits minimum cabinet size 900mm wide x 500mm depth.
- Left or right hand configurations.
- Two pull-out shelves with chrome railing and grey anti-slip matting.
- Shelves are mounted onto white arms which rotate around a steel pole.
- Shelves can be pulled out individually and are height adjustable.
- Easy to install.
- Smooth sliding motion.
- 15kg capacity per shelf.
- Quality materials and construction.
- Minimum door opening 415mm.
- Soft Closing Kit included



Code	Description
5511200#	Left Hand
5511201#	Right Hand

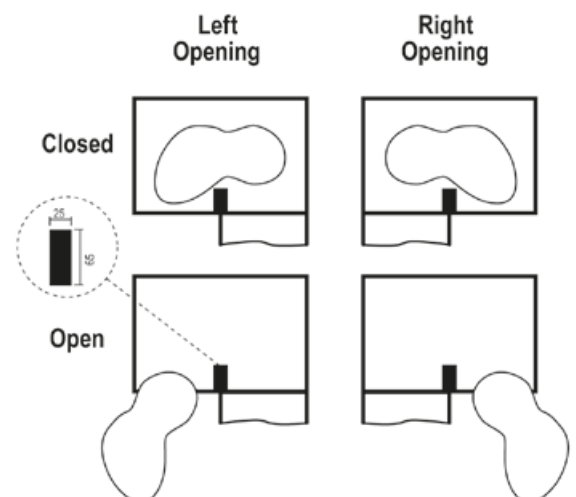

# KITCHEN STORAGE

## ARTIA CABINET HARDWARE SYSTEMS WASTE ORGANISERS

### ▶ Artia Cabinet Hardware Systems 2 x 20L Waste Organisers with Self-Close Runners

- Quality materials and construction
- Steel frames and mounting brackets
- Removable bin inserts.
- Available fitted with door mount brackets.
- Full extension slides



Code	Door Bracket	Capacity	Configuration
<b>565.00004.001</b>	-	40 litres	2 x 20 litre
<b>565.00005.001</b>	Included	40 litres	2 x 20 litre

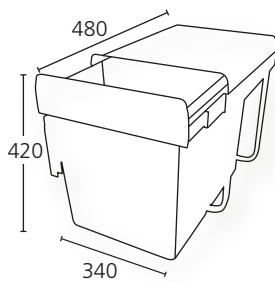

### ▶ Artia Cabinet Hardware Systems 2 x 15L Waste Organisers with Soft-Close Runners

- Quality materials and construction
- Steel frames and mounting brackets
- Removable bin inserts.
- Available fitted with door mount brackets.
- Full extension slides



Code	Door Bracket	Capacity	Configuration
<b>565.00006.001</b>	-	30 litres	2 x 15 litre
<b>565.00007.001</b>	Included	30 litres	2 x 15 litre

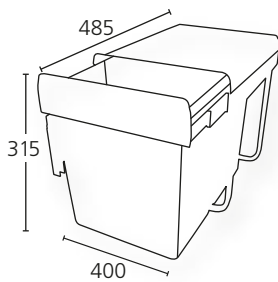

## KIMBERLEY™ CUTLERY INSERTS

### ▶ Kimberley™ Moulded Cutlery Inserts

- Constructed in durable hi-impact styrene
- Side flanges for easy trimming to suit large drawers
- 767202 has large deeper compartments and is suited to cabinets up to 600mm



Code	Depth (mm)	Width (mm)	Height (mm)
<b>767201</b>	346-435	306-450	55
<b>767202</b>	373-483	482-532	55



# KITCHEN STORAGE

## KIMBERLEY™ PULL OUT CORNER UNITS

### ▶ Kimberley™ 270° Lazy Susan

- 270° Lazy Susan carousel
- Popular corner cabinet storage solution
- Consists of two carousel trays rotating around pole
- White PVC tray
- Built in catch mechanism to locate and hold shelves in correct position

KIMBERLEY™



Code	Description
767001	720mm diameter; white

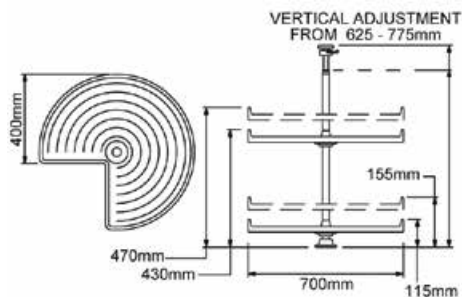

## KIMBERLEY™ WASTE ORGANISER SOLUTIONS

### ▶ Kimberley™ 10L Automatic Waste Bin

- 10l capacity
- Automatically opening lid
- Designed to mount inside cupboard
- Hi-impact plastic bin with handle, removable for easy cleaning
- Right or left opening (interchangeable)

KIMBERLEY™



Code	Description
767005	White
767010	Stainless Steel

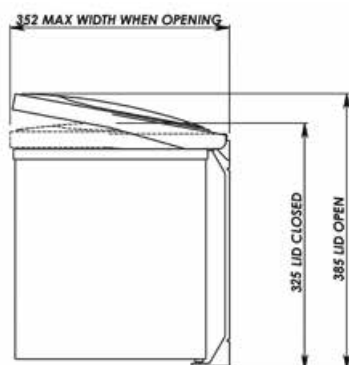

# KITCHEN STORAGE

## KIMBERLEY™ WASTE ORGANISER SOLUTIONS

### ▶ Kimberley™ 30L Twin Bin Waste Separation System (320mm Wide)

- 30L storage capacity
- Sturdy hi-impact plastic frame
- Removeable hi-impact plastic bins – easy to clean
- Suit left or right hand opening
- Cleverly designed closed lid results in minimal airflow, preventing odours

Code	D	W	H	Colour	Size
<b>767006</b>	525mm	320mm	340mm	White	30 Litre

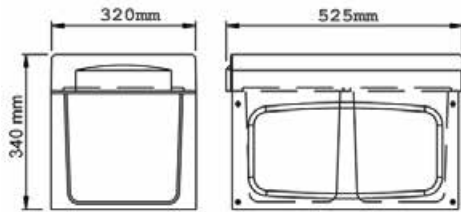

KIMBERLEY™

### ▶ Kimberley™ 30L Twin Bin Waste Separation System (350mm Wide)

- 30L storage capacity
- Uniquely stackable construction
- Robust solid tubular metal frame
- Removeable hi-impact plastic bins – easy to clean
- Suit left or right hand opening
- Cleverly designed closed lid results in minimal airflow, preventing odours

Code	D	W	H	Colour	Size
<b>565.KRB06.001</b>	525mm	350mm	340mm	White	30 Litre

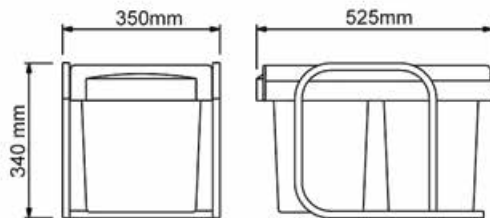

KIMBERLEY™

### ▶ Kimberley™ 30L Twin Bin Waste Separation System (Door Mounted)

- 30L storage capacity
- No additional runners or hinges required
- Robust solid tubular metal frame
- Removeable hi-impact plastic bins – easy to clean
- Fascia panel attaches directly to bin

Code	D	W	H	Colour	Size
<b>565.KRB06D.001#</b>	525mm	350mm	340mm	White	30 Litre

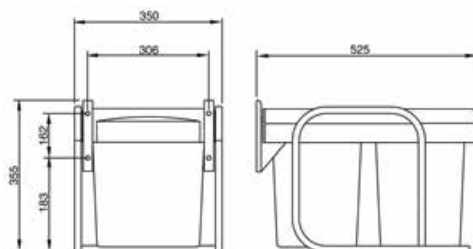

KIMBERLEY™



# KITCHEN STORAGE

## TECHNICAL INFORMATION

### Legend

**X** Minimum Internal Cabinet Width | **X2** Door Width | **Y** Minimum Internal Cabinet Depth | **Z** Minimum Internal Cabinet Height

► **Sige Side-Mount Pull Out – 2 Basket**  
page 06

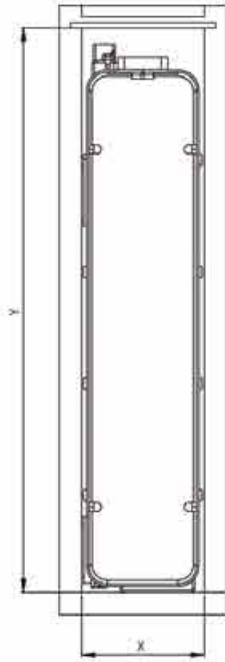

Code	☐	W	D	H
191401	150	110	500	520

► **Sige Pull Out Shelf / Basket**  
page 05

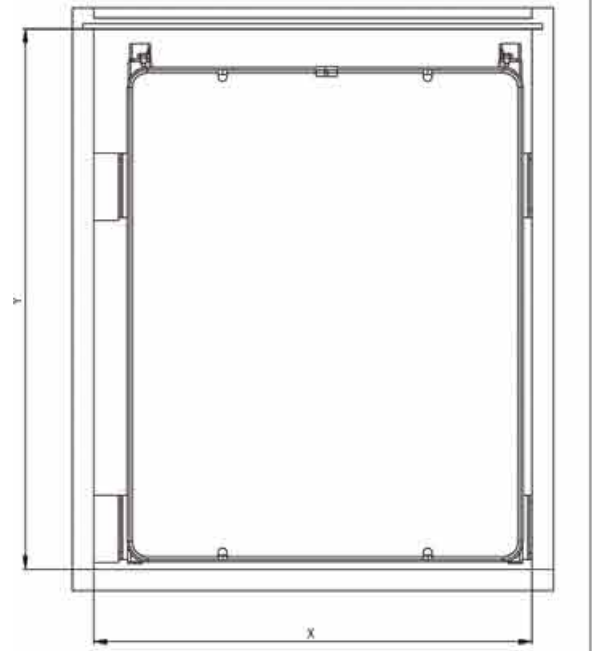

Code	☐	W	D	H
191404	450	410-418	500	160
191405	600	560-568	500	160

► **Sige Bottom-Mount Pull Out – 2 Basket**  
page 06

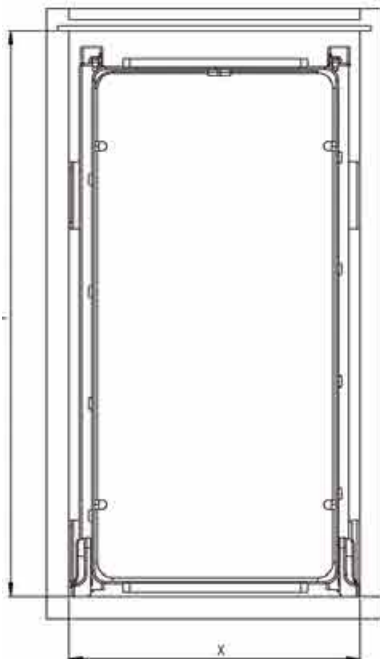

Code	☐	W	D	H
191418	300	260-268	500	520
191419	450	410-418	500	520

► **Sige Tandem Pull Out**  
page 05

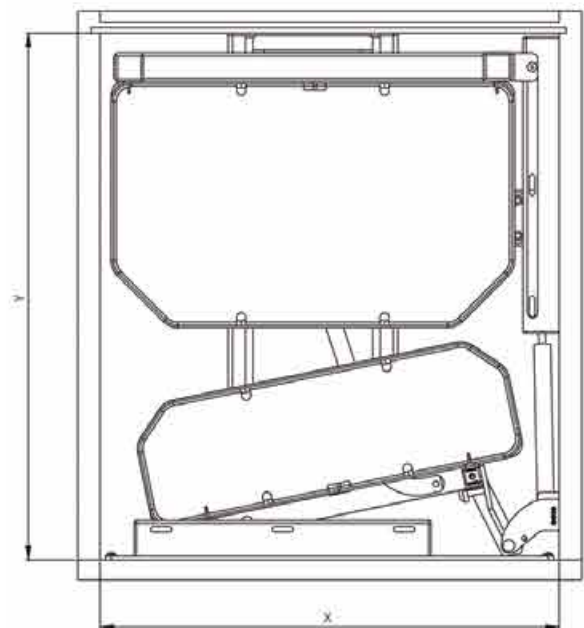

Code	☐	W	D	H
191414#	450	410	470	1800
191415#	600	560	470	1800

# KITCHEN STORAGE

## TECHNICAL INFORMATION

### Legend

**X** Minimum Internal Cabinet Width **X2** Door Width **Y** Minimum Internal Cabinet Depth **Z** Minimum Internal Cabinet Height

#### ► Sige Pull Out Pantry Basket page 04

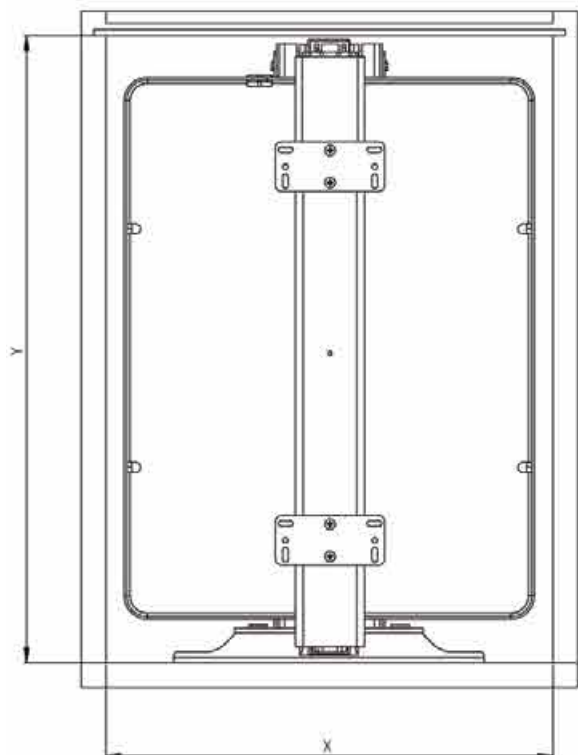

Code	#	W	D	H	Qty
191530	300	230	440	120	5
191540	400	330	440	120	5
191550	500	430	440	120	5

#### ► Sige Pull Out Swing Corner Shelf page 07

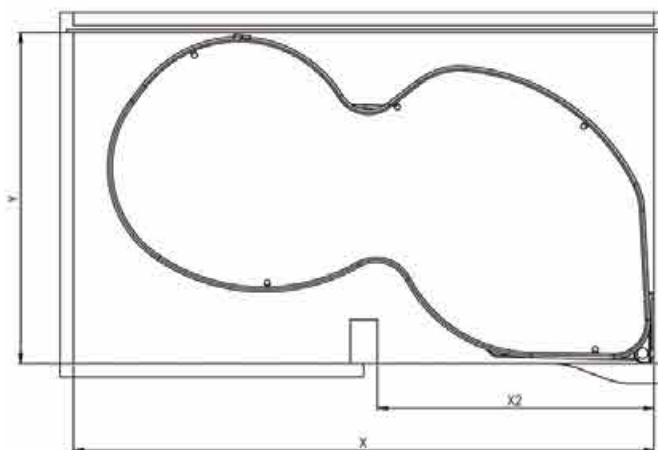

Code	Installation	W	D	H
191412	Left	900	450	500
191413	Right	900	450	500

#### ► Sige Pull Out Corner Unit page 07

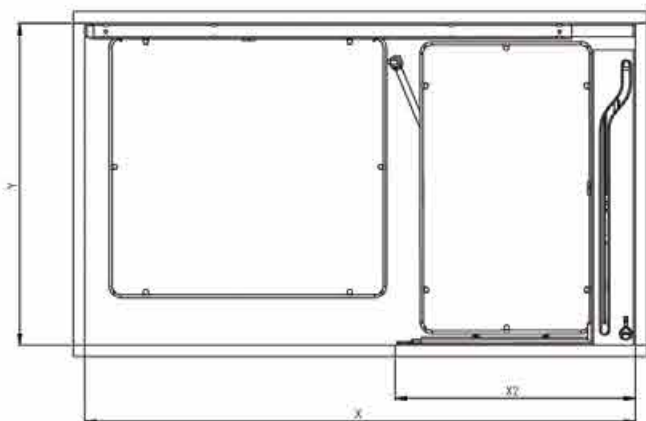

Code	Installation	W	D	H	
191408	Left	Min. 900	860	500	600
191409	Right	Min. 900	860	500	600

# KITCHEN STORAGE

## TECHNICAL INFORMATION

► Sige Laundry Hamper  
page 12



Code	□	W	D	H
191505	450	410-418	505	590

### Basket Dimensions

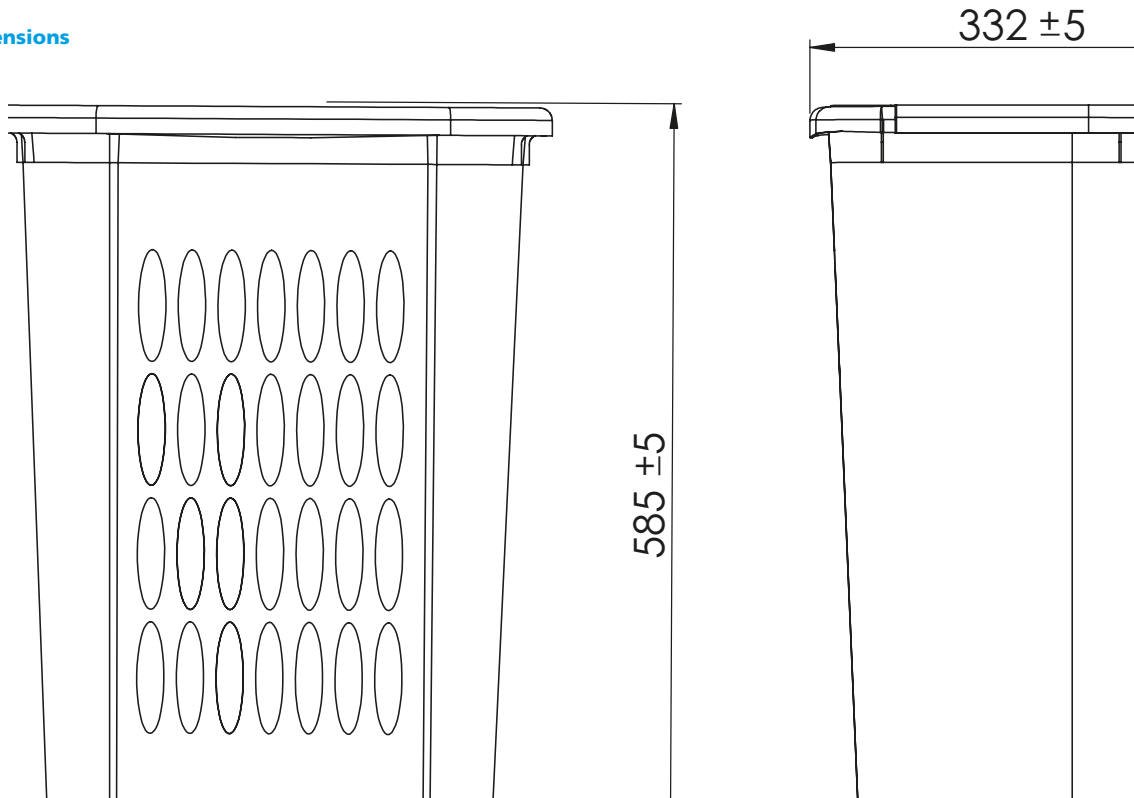

### Drilling Dimensions

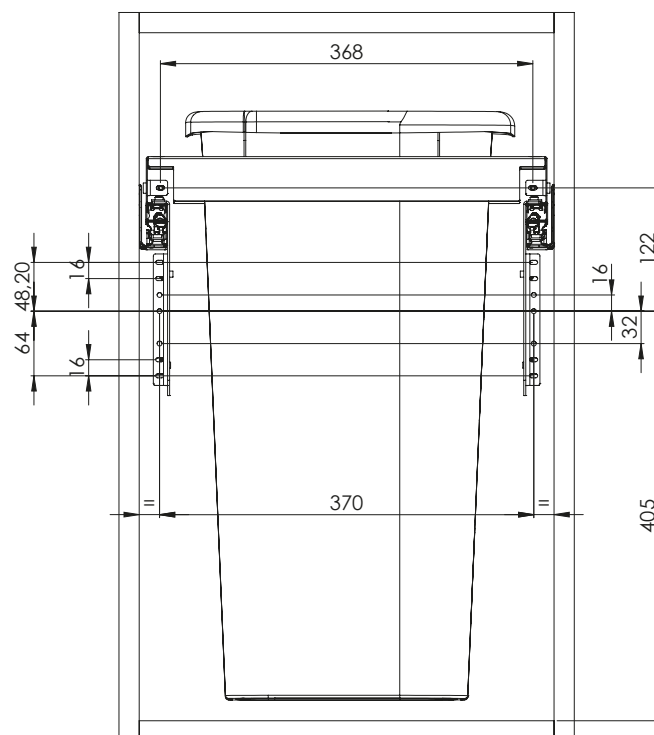

# KITCHEN STORAGE

## INDEX PART NUMBERS

Part Number	Page
551.GSG2B30D.340	13
551.GSG2B40D.340	13
551.GZHN119U2C.340	13
551.GZHN119U3C.340	13
551.GZHN168U2C.340	13
551.GZHN168U3C.340	13
551.OS4D1046.340	14
551.OS4D4046.340	14
551.OS4D4546.340	14
551.OS4D5046.340	14
551.OS4D6046.340	14
551.OS4D7046.340	14
551.OS4D8046.340	14
551.OS4D9046.340	14
565.00004.001	16
565.00005.001	16
565.00006.001	16
565.00007.001	16
565.KRB06.001	18
565.KRB06D.001#	18
191301	09
191303	09
191305	10, 12
191307	10
191309	11
191317	11
191401	06, 19
191404	05, 19
191405	05, 19
191406	04
191407	04
191408	07, 20
191409	07, 20
191412	07, 20
191413	07, 20
191414#	05, 19
191415#	05, 19
191416	08
191417	08
191418	06, 19
191419	06, 19
191430	04

# KITCHEN STORAGE

## INDEX PART NUMBERS

Part Number.....	Page
191440.....	<b>04</b>
191450.....	<b>04</b>
191466.....	<b>06</b>
191505.....	<b>12, 21</b>
191530.....	<b>04, 20</b>
191530-1.....	<b>04</b>
191540.....	<b>04, 20</b>
191540-1.....	<b>04</b>
191550.....	<b>04, 20</b>
191550-1.....	<b>04</b>
767001.....	<b>17</b>
767005.....	<b>17</b>
767006.....	<b>18</b>
767010.....	<b>17</b>
767201.....	<b>16</b>
767202.....	<b>16</b>
5511200.....	<b>15</b>
5511201.....	<b>15</b>





**CABINET HARDWARE SYSTEMS**

## KITCHEN STORAGE

# Version 1.0

### Australia

1800 008 591 ■ [www.artia.com.au](http://www.artia.com.au)

**VICTORIA:**

235 Settlement Road,  
Thomastown VIC 3074

**NEW SOUTH WALES:**

Unit 1/429 Victoria Street,  
Wetherill Park NSW 2164

**QUEENSLAND:**

Building 2/660 MacArthur  
Avenue, Pinkenba QLD 4008

**SOUTH AUSTRALIA:**

13 Rosberg Road,  
Wingfield SA 5013

**WESTERN AUSTRALIA:**

Unit 1B/15 Hector Street,  
Osborne Park WA 6017

### New Zealand

0800 267 625 ■ [www.artia.co.nz](http://www.artia.co.nz)

**AUCKLAND:**

11 Bruce Roderick Drive,  
East Tamaki, Auckland 2013

**CHRISTCHURCH:**

117 Wrights Road,  
Addington, Christchurch 8024