



CABINET HARDWARE SYSTEMS

KNOBS & HANDLES

#KAH2.0

Australia

1800 008 591 ■ www.artia.com.au

VICTORIA:

235 Settlement Road,
Thomastown VIC 3074

NEW SOUTH WALES:

6 Nello Place
Wetherill Park NSW 2164

QUEENSLAND:

Building 2/660 MacArthur
Avenue, Pinkenba QLD 4008

SOUTH AUSTRALIA:

13 Rosberg Road,
Wingfield SA 5013

WESTERN AUSTRALIA:

Unit 5/1 Dellamarta Road,
Wangara WA 6065

New Zealand

0800 267 625 ■ www.artia.co.nz

AUCKLAND:

11 Bruce Roderick Drive,
East Tamaki, Auckland 2013

CHRISTCHURCH:

117 Wrights Road,
Addington, Christchurch 8024

KNOBS & HANDLES

CONTENTS

▪ 86	20
▪ 201	20
▪ 203	20
▪ Adatto.....	23
▪ Ancona	12
▪ Angol.....	06
▪ Aosta	17
▪ Avila.....	23
▪ Axis.....	11
▪ Bar 12	17
▪ Beckett.....	31
▪ Bologna.....	16
▪ Bow	15
▪ Brixton	26
▪ Brunel	25
▪ Cage.....	25
▪ Cera.....	08
▪ Cono C	28
▪ Cremona.....	23
▪ D8.....	19
▪ D10.....	19
▪ Elba.....	11
▪ Entrata	12
▪ Epoch.....	25
▪ Foro	15
▪ Fuso	18
▪ Hamptons	04
▪ Jay.....	22
▪ Jay 2.0.....	22
▪ Lastra	21
▪ Lata.....	10
▪ Latina	10
▪ Livigno	29
▪ Lucca.....	13
▪ Lumina.....	12
▪ Mansell	31
▪ Montoya	31
▪ Octagono.....	28
▪ Orbita.....	28
▪ Palo.....	17
▪ Parabola	14
▪ Pavia	16
▪ Picos.....	09
▪ Placca.....	20
▪ Pucon.....	16
▪ Razor.....	11
▪ Retto.....	11
▪ Rotollo	18

KNOBS & HANDLES

CONTENTS

▪ Rutland	24
▪ Scalloped.....	26
▪ Segni.....	30
▪ Semi.....	30
▪ Sente.....	15
▪ Senterio.....	15
▪ Sierra.....	14
▪ Stelvio	27
▪ Stratford.....	28
▪ Tacca	30
▪ Tapered Bow	16
▪ Tarra.....	21
▪ Tours	30
▪ Udine	23
▪ Valle.....	23
▪ Vaniglia	05
▪ Venti	12
▪ Verde	07
▪ Veroli.....	14
▪ Vetro.....	28
▪ Vizzini	18
▪ Waterfall	21

TO CARE FOR YOUR HANDLES:

Clean the handles using a microfibre cloth or with a solution of warm water and a small amount of washing-up liquid applied with a soft sponge. Wipe the surfaces dry using a soft cloth. For cleaning, you can also use a clean, damp microfibre cloth without any cleaning agent.

AVOIDING DAMAGE TO THE SURFACE.

TO PREVENT DAMAGE TO YOUR HANDLES WHEN CLEANING, DO NOT USE:

- Cleaning agents containing soda, ammonia, acids or chlorides
- Cleaning agents containing descaling agents
- Abrasive cleaning agents, e.g. powder cleaners and cream cleaners
- Solvent-based cleaning agents
- Stainless steel cleaners
- Dishwasher detergent
- Oven sprays
- Glass cleaning agents
- Hard, abrasive sponges and brushes e.g. pot scourers
- Dirt erasers
- Sharp metal scrapers



Legend

C/C	Centre to Centre	P	Projection
L	Length	D	Diameter
W	Width	T	Thread

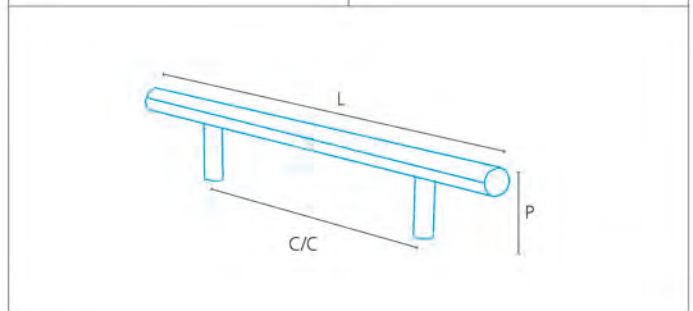
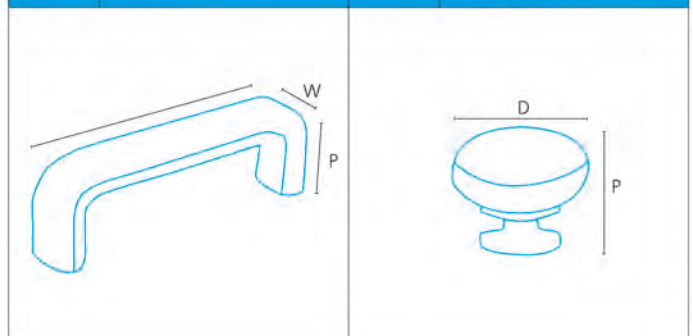





KNOBS & HANDLES

MODERN. Inspirations

HAMPTONS

Artia's new HAMPTONS family of knobs & handles are designed to enhance this style with a modern interpretation & a touch of traditional appeal.

Describes a sophisticated yet relaxed coastal or rural design, and has become a sustained trend that features "shaker" style kitchens with framed door panels, for example.

▶ Hamptons					
CODE		C/C	L	W	P
Finish: Brushed Nickel 					
11937.076.412	Shell pull handle	76	118	20	31
11937.128.412	Handle	128	160	14	25
Finish: Matt Black 					
11937.076.002	Shell pull handle	76	118	20	31
11937.128.002	Handle	128	160	14	25
CODE		P		D	
Finish: Brushed Nickel 					
11937.032.412	Knob	33		35	
Finish: Matt black 					
11937.032.002	Knob	33		35	



11937.076.412



11937.032.412



11937.076.002



11937.032.002



11937.128.002



11937.128.412



KNOBS & HANDLES



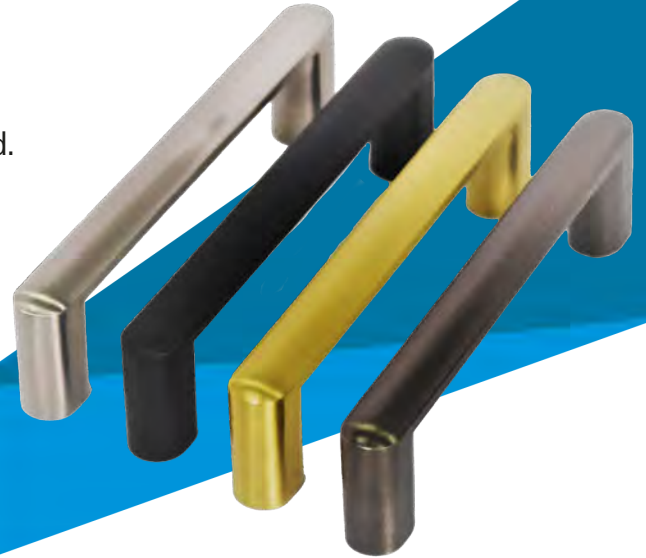

MODERN. Inspirations

VANIPLIA

Linear design with rounded ends and smooth edges all around. Available in four finishes to subtly enhance the latest interior design trends. Offered in up to five lengths, to cover standard cutlery drawers all the way through to tall pantry doors.



- Brushed Nickel – Universally appealing with its elegant lustre.
- Matt Black – Ideal to create a stark contrast with light cabinet fronts.
- Anthracite – Artia’s latest finish, for when the design calls for some dark, sumptuous mystery.
- Matt Gold – Adding a touch of luxury.

▶ VANIPLIA				
CODE	C/C	L	W	P
Finish: Brushed Nickel 				
111. 70206.412	96	110	10	31
111. 70209.412	128	142	10	31
111. 70210.412	160	174	10	31
111. 70213.412	256	270	10	31
111. 70215.412	320	334	10	31
Finish: Matt Black 				
111.70206.002	96	110	10	31
111.70209.002	128	142	10	31
111.70210.002	160	174	10	31
111.70213.002	256	270	10	31
111.70215.002	320	334	10	31
Finish: Anthracite 				
111.70206.123	96	110	10	31
111.70209.123	128	142	10	31
111.70210.123	160	174	10	31
111.70213.123	256	270	10	31
111.70215.123	320	334	10	31
Finish: Matt Gold 				
111.70206.611	96	110	10	31
111.70210.611	160	174	10	31
111.70213.611	256	270	10	31

For a matching knob, why not combine it with Artia’s new STELVIO?







KNOBS & HANDLES

MODERN. Inspirations

ANGOL



▶ Angol				
CODE	C/C	L	W	P
Finish: Brushed Nickel 				
111.70506.412	96	108	10	28
111.70509.412	128	140	10	28
111.70510.412	160	172	10	28
111.70513.412	256	268	10	28
111.70515.412	320	332	10	28
Finish: Vintage Bronze 				
111.70506.413	96	108	10	28
111.70509.413	128	140	10	28
111.70510.413	160	172	10	28
111.70513.413	256	268	10	28
111.70515.413	320	332	10	28
Finish: Matt Black 				
111.70506.002	96	108	10	28
111.70509.002	128	140	10	28
111.70510.002	160	172	10	28
111.70513.002	256	268	10	28
111.70515.002	320	332	10	28
Finish: Chrome 				
111.70506.340	96	108	10	28
111.70509.340	128	140	10	28
111.70510.340	160	172	10	28
111.70513.340	256	268	10	28
111.70515.340	320	332	10	28







KNOBS & HANDLES

MODERN. Inspirations

VERDE



▶ Verde				
CODE	C/C	L	W	P
Finish: Brushed Nickel 				
111.71709.412	128	144	17	28
111.71710.412	160	176	17	28
111.71713.412	256	272	17	28
111.71715.412	320	336	17	28
Finish: Vintage Bronze 				
111.71709.413	128	144	17	28
111.71710.413	160	176	17	28
111.71713.413	256	272	17	28
111.71715.413	320	336	17	28
Finish: Matt Black 				
111.71709.002	128	144	17	28
111.71710.002	160	176	17	28
111.71713.002	256	272	17	28
111.71715.002	320	336	17	28
Finish: Chrome 				
111.71709.340	128	144	17	28
111.71710.340	160	176	17	28
111.71713.340	256	272	17	28





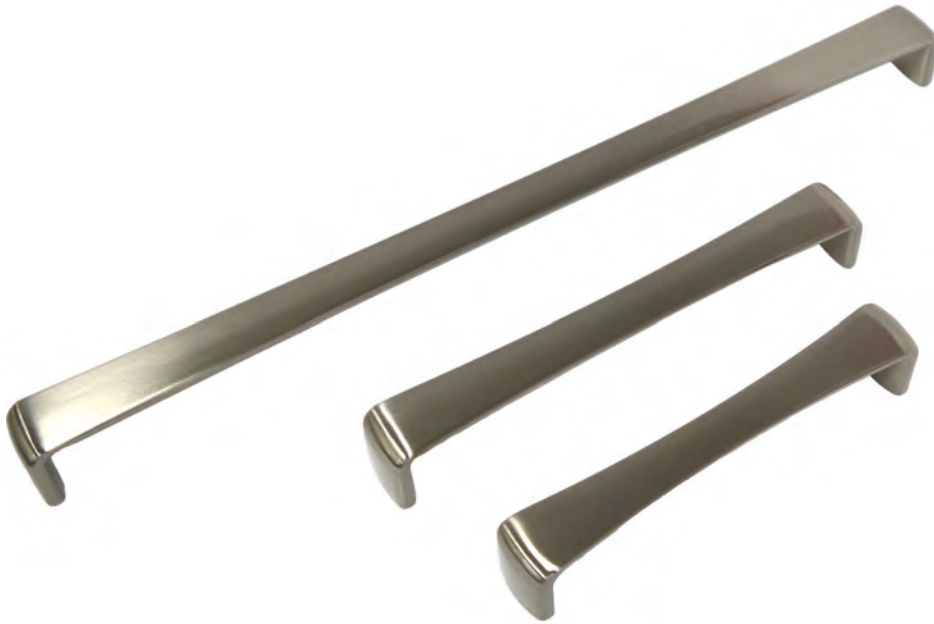

KNOBS & HANDLES

MODERN. Inspirations

CERA



► Cera				
CODE	C/C	L	W	P
Finish: Brushed Nickel 				
111.71606.412	96	102	20	25
111.71609.412	128	134	20	25
111.71610.412	160	166	20	25
111.71613.412	256	262	20	25
111.71615.412	320	326	20	25
Finish: Vintage Bronze 				
111.71606.413	96	102	20	25
111.71609.413	128	134	20	25
111.71610.413	160	166	20	25
111.71613.413	256	262	20	25
111.71615.413	320	326	20	25
Finish: Matt Black 				
111.71606.002	96	102	20	25
111.71609.002	128	134	20	25
111.71610.002	160	166	20	25
111.71613.002	256	262	20	25
111.71615.002	320	326	20	25
Finish: Chrome 				
111.71609.340	128	134	20	25
111.71610.340	160	166	20	25
111.71613.340	256	262	20	25







For a matching knob, why not combine it with Artia's new STELVIO?

KNOBS & HANDLES

MODERN. Inspirations

PICOS



► Picos				
CODE	C/C	L	W	P
Finish: Brushed Nickel 				
111.70606.412	96	106	14	24
111.70609.412	128	138	14	24
111.70610.412	160	170	14	24
111.70613.412	256	266	14	24
111.70615.412	320	330	14	24
Finish: Vintage Bronze 				
111.70606.413	96	106	14	24
111.70609.413	128	138	14	24
111.70610.413	160	170	14	24
111.70613.413	256	266	14	24
111.70615.413	320	330	14	24
Finish: Matt Black 				
111.70606.002	96	106	14	24
111.70609.002	128	138	14	24
111.70610.002	160	170	14	24
111.70613.002	256	266	14	24
111.70615.002	320	330	14	24
Finish: Chrome 				
111.70606.340	96	106	14	24
111.70609.340	128	138	14	24
111.70610.340	160	170	14	24
111.70613.340	256	266	14	24
111.70615.340	320	330	14	24





KNOBS & HANDLES

MODERN. Wide Base

LATA



► Lata

CODE	C/C	L	W	P
Finish: Brushed Nickel 				
111.02306.412	96	130	9	28
111.02309.412	128	162	9	28
111.02310.412	160	194	9	28
111.02312.412	224	258	9	28
111.02313.412	256	290	9	28
111.02315.412	320	352	9	28
Finish: Matt Black 				
111.02306.002	96	130	9	28
111.02309.002	128	162	9	28
111.02310.002	160	194	9	28
111.02312.002	224	258	9	28
111.02313.002	256	290	9	28
111.02315.002	320	352	9	28
Finish: Matt Gold 				
111.02306.611	96	130	9	28
111.02310.611	160	194	9	28
111.02313.611	256	290	9	28



For a matching knob, why not combine it with Artia's new STELVIO?



LATINA



► Latina

CODE	C/C	L	W	P
Finish: Chrome 				
141.02309.387	128	150	8	27
141.02311.387	192	220	8	27
141.02313.387	256	290	8	27
Finish: Matte Chrome 				
141.02309.395	128	150	8	27
141.02311.395	192	220	8	27
Finish: Brushed Nickel 				
141.02309.412	128	150	8	27
141.02311.412	192	220	8	27
141.02313.412	256	290	8	27
141.02315.412	320	358	8	27

KNOBS & HANDLES

MODERN. Wide Base



ELBA



▶ Elba				
CODE	C/C	L	W	P
Finish: Brushed Nickel 				
055132	96	120	11	24
055134	128	154	11	24
055136	160	186	11	24
055142	256	282	11	24
055146	320	346	11	24



RAZOR



▶ Razor				
CODE	C/C	L	W	P
Finish: Chrome 				
055001#	224	232	8	33
Finish: Brushed Nickel 				
055003#	224	232	8	33

RETTO



▶ Retto				
CODE	C/C	L	W	P
Finish: Chrome 				
055873#	160	192	14	30
Finish: Brushed Nickel 				
055875#	160	192	14	30

AXIS



▶ Axis				
CODE	C/C	L	W	P
Finish: Brushed Nickel 				
111.20009.412	128	163	20	27
111.20010.412	160	195	20	27
111.20013.412	256	291	20	27
111.20015.412	320	355	20	27

KNOBS & HANDLES

MODERN. Rectangular Profile

ENTRATA



▶ Entrata				
CODE	C/C	L	W	P
Finish: Brushed Stainless Steel 				
116.81209.316	128	140	12	32
116.81210.316	160	172	12	32
116.81211.316	192	204	12	32
116.81214.316	288	300	12	32

12 x 12mm profile

VENTI



▶ Venti				
CODE	C/C	L	W	P
Finish: Brushed Stainless Steel 				
116.80010.316	160	168	20	30
116.80014.316	288	296	20	30

20 x 8mm profile

ANCONA



▶ Ancona				
CODE	C/C	L	W	P
Finish: Brushed Nickel 				
055472	96	108	12	30
055473	128	140	12	30
055474	160	172	12	30
055475	192	204	12	30
055476	224	236	12	30
055477	256	268	12	30
055479	320	332	12	30
055481	416	428	12	30
055483	512	524	12	30

LUMINA







▶ Lumina				
CODE	C/C	L	W	P
Finish: Brushed Nickel 				
111.07506.412	96	104	22	25
111.07509.412	128	136	22	25
111.07510.412	160	170	22	25
111.07512.412	224	234	22	25
111.07515.412	320	330	22	25

KNOBS & HANDLES

MODERN. Feature Profile

LUCCA





► Lucca				
CODE	C/C	L	W	P
Finish: Chrome 				
141.59306.387	96	104	12	27
141.59309.387	128	136	12	27
141.59310.387	160	168	12	27
141.59312.387	224	232	12	27
141.59314.387	288	296	12	27
Finish: Matte Chrome 				
141.59306.395	96	104	12	27
141.59309.395	128	136	12	27
141.59310.395	160	168	12	27
141.59312.395	224	232	12	27
141.59314.395	288	296	12	27
Finish: Brushed Nickel 				
141.59306.412	96	104	12	27
141.59309.412	128	136	12	27
141.59310.412	160	168	12	27
141.59312.412	224	232	12	27
141.59314.412	288	296	12	27
141.59315.412	320	328	12	27
141.59316.412	352	360	12	27
141.59319.412	448	456	12	27
Finish: Matt Black 				
141.59306.002	96	104	12	27
141.59309.002	128	136	12	27
141.59310.002	160	168	12	27
141.59312.002	224	232	12	27
141.59314.002	288	296	12	27

KNOBS & HANDLES

MODERN. Feature Profile

VEROLI



▶ Veroli				
CODE	C/C	L	W	P
Finish: Chrome 				
055843	128	139	22	26
055846	160	170	22	26
055849	224	234	22	26
055852	288	298	22	26
Finish: Satin Chrome 				
055844	128	139	22	26
055847	160	170	22	26
055850	224	234	22	26
055853#	288	298	22	26
Finish: Brushed Nickel 				
054842	96	105	22	26
055845	128	139	22	26
055848	160	170	22	26
055851	224	234	22	26
055854	288	298	22	26

CURVED. Feature Profile

PARABOLA



▶ Parabola				
CODE	C/C	L	W	P
Finish: Brushed Nickel 				
054484	128	151	20	32
054485	160	185	20	32
054486	192	230	20	32
054487	224	264	20	32
054488	288	336	20	32
054489	320	375	20	32

SIERRA



▶ Sierra				
CODE	C/C	L	W	P
Finish: Brushed Nickel 				
141.27306.412-1	96	108	15	32
141.27309.412-1	128	146	15	30

KNOBS & HANDLES

MODERN. Feature Profile

FORO



▶ Foro				
CODE	C/C	L	W	P
Finish: Satin Black 				
141.45906.402#	96	145	15	26

SENTE



▶ Sente				
CODE	C/C	L	W	P
Finish: Brushed Nickel 				
111.78510.412#	160	171	25	22

SENTERIO





▶ Senterio				
CODE	C/C	L	W	P
Finish: Brushed Nickel 				
055156	160	172	21	25
055160	224	237	21	25

CURVED. Round Profile

BOW



▶ Bow				
CODE	C/C	L	W	P
Finish: Black Nickel 				
290795	96	114	10	30
Finish: Chrome 				
290796	96	114	10	30
290800	128	152	10	30
Finish: Satin Chrome 				
290798	96	114	10	30
290802	128	152	10	30





KNOBS & HANDLES

CURVED. Round Profile

TAPERED BOW





▶ Tapered Bow

CODE	C/C	L	W	P
Finish: Black Nickel 				
055695	96	114	10	27
055704-1	128	145	10	30
Finish: Chrome 				
055696#	96	114	10	27
055696-1	96	114	10	27
055700	128	145	10	30
141.90512.387	224	290	14	32
Finish: Satin Chrome 				
055698-1	96	114	10	27
055702	128	145	10	30
Finish: Satin Nickel 				
055699-1	96	114	10	27
Finish: Brushed Nickel 				
055705	96	114	10	27
055706-1	128	145	10	30
141.90510.412	160	206	12	31
141.90512.412	224	290	14	32

PUCON



▶ Pucon

CODE	C/C	L	W	P
Finish: Satin Chrome 				
054395-1	128	168	19	30
Finish: Brushed Nickel 				
054394	128	168	19	30

BOLOGNA



▶ Bologna

CODE	C/C	L	W	P
Finish: Brushed Nickel 				
141.22606.412	96	113	11	22
141.22609.412	128	153	13	26

PAVIA



▶ Pavia

CODE	C/C	L	W	P
Finish: Brushed Nickel 				
141.85906.412	96	135	10	31
141.85909.412	128	165	10	31



KNOBS & HANDLES

ROUND PROFILE. Round Base

BAR 12



► Bar 12

CODE	C/C	L	W	P
Finish: Brushed Nickel 				
121.26006.336	96	146	12	35
121.26009.336	128	178	12	35
121.26010.336	160	210	12	35
121.26011.336	192	242	12	35
121.26012.336	224	274	12	35
121.26014.336	288	338	12	35
121.26015.336	320	370	12	35
121.26018.336	544	594	12	35
121.26019.336#	640	690	12	35
Finish: Chrome 				
121.26006.340	96	146	12	35
121.26009.340	128	178	12	35

PALO



► Palo

CODE	C/C	L	W	P
Finish: Brushed Stainless Steel 				
116.86006.320	96	108	12	30
116.86009.320	128	140	12	30
116.86010.320	160	172	12	30
116.86011.320	192	204	12	30
116.86014.320	288	300	12	30
116.86016.320	352	364	12	30
116.86020.320	480	492	12	30

AOSTA



► Aosta

CODE	C/C	L	W	P
Finish: Brushed Nickel 				
141.26806.412#	96	108	12	32
141.26810.412#	160	172	12	32

KNOBS & HANDLES

ROUND PROFILE. Square Base

FUSO



▶ Fuso				
CODE	C/C	L	W	P
Finish: Brushed Stainless Steel 				
054335	128	148	10	37
054336	224	244	10	37
054337	320	340	10	37

ROTOLLO



▶ Rotollo				
CODE	C/C	L	W	P
Finish: Brushed Nickel 				
141.79009.412	128	170	14	16
141.79010.412	160	202	14	16
141.79011.412	192	234	14	16
141.79012.412	224	266	14	16
141.79013.412	256	298	14	16
141.79014.412	288	330	14	16
141.79015.412	320	362	14	16
141.79016.412	352	394	14	16
141.79018.412	416	458	14	16
141.79066.412	640	682	14	16

VIZZINI



▶ Vizzini				
CODE	C/C	L	W	P
Finish: Brushed Nickel 				
141.80606.412	96	125	12	34
141.80609.412	128	157	12	34
141.80610.412	160	199	12	34
141.80613.412	256	285	12	34
141.80615.412	320	349	12	34



KNOBS & HANDLES

D-SHAPE.

D8



► D8





CODE	C/C	L	W	P
Finish: Chrome 				
054749	76	83	8	30
054752	96	104	8	30
Finish: Satin Chrome 				
054750	76	83	8	30
054753	96	104	8	30

Available in Imperial 3"

D10



► D10

CODE	C/C	L	W	P
Finish: Brushed Stainless Steel 				
054271	96	106	10	35
054272	128	137	10	35
054275	224	235	10	35
Finish: Brushed Nickel 				
121.22406.336	96	106	10	35
121.22409.336	128	137	10	35
121.22410.336	160	169	10	35
Finish: Chrome 				
054281	96	106	10	35
054282	128	137	10	35
Finish: Satin Chrome 				
054291	96	106	10	35
054292	128	137	10	35
054295	224	235	10	35
054296	320	330	10	35

KNOBS & HANDLES

PULL. Pull

PLACCA



► Placca

CODE	C/C	L	W	P
Finish: Matte Chrome 				
143.98901.395	32	40	40	8
143.98903.395	64	72	40	8

HANDLE. Plastic

86



► 86

CODE		L	W	P
Finish: Arctic White (.088) 				
161.08684.088	Face fix for Rivets	180	45	40

201



► 201

CODE	C/C	L	W	P
Finish: White 				
161.20106.001	96	112	16	38
Finish: Black 				
161.20106.002	96	112	16	38

203



► 203

CODE	C/C	L	W	D
Finish: White 				
161.20306.001	96	108	19	19

KNOBS & HANDLES

PULL. Slim

LASTRA

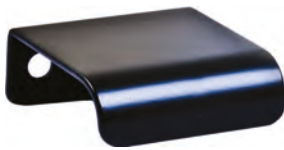

▶ Lastra				
CODE	C/C	L	W	P
Face Fix From Rear				
Finish: Polished Chrome 				
131.39680.423	26	38	12	36
Finish: Satin Nickel 				
131.39680.431	26	38	12	36
Finish: Satin Black 				
131.39680.432	26	38	12	36
Finish: Brushed Nickel 				
131.39680.438	26	38	12	36



WATERFALL



▶ Waterfall				
CODE	C/C	L	W	P
Finish: Matte Nickel 				
141.66801.394	32	90	12	20

TARRA





▶ Tarra				
CODE	C/C	L	W	P
Finish: Brushed Nickel 				
111.31106.412	96	110	6	44
111.31110.412	160	174	6	44
111.31115.412	320	334	6	44
Finish: Satin Aluminium 				
111.31199.301	1200	1470	6	44

KNOBS & HANDLES

PULL. Shell



JAY



▶ Jay				
CODE	C/C	L	W	P
Finish: Brushed Stainless Steel 				
116.33379.320	20	30	11.5	38
116.33336.320	80	100	11.5	38
116.33200.320	160	200	11.5	38
Finish: Chrome 				
111.33100.387	80	100	11.5	38

JAY 2.0





▶ JAY 2.0				
CODE	C/C	L	W	P
Finish: Matt White 				
111.33031.001	20	30	11.5	38
111.33101.001	80	100	11.5	38
111.33201.001	160	200	11.5	38
111.33301.001	220	300	11.5	38
111.33501.001	420	500	11.5	38
Finish: Matt Black 				
111.33031.002	20	30	11.5	38
111.33101.002	80	100	11.5	38
111.33201.002	160	200	11.5	38
111.33301.002	220	300	11.5	38
111.33501.002	420	500	11.5	38
Finish: Brushed Nickel 				
111.33031.412	20	30	11.5	38
111.33101.412	80	100	11.5	38
111.33201.412	160	200	11.5	38
111.33301.412	220	300	11.5	38
111.33501.412	420	500	11.5	38

KNOBS & HANDLES

RECESSED

AVILA



▶ Avila				
CODE	P	D	R*	
Finish: Satin Chrome 				
054768	2	41	35 x 8	
054770	3	49	35 x 8	
Finish: Brushed Nickel 				
054767	2	41	35 x 8	

* Recess Size

ADATTO



▶ Adatto				
CODE	L	W	P	R*
Finish: Brushed Stainless Steel with Black Plastic Plate 				
185250	44	44	3	35 x 10

* Recess Size

CREMONA



* Reversible Back Plate

▶ Cremona				
CODE	C/C	L	W	
Finish: Brushed Nickel 				
055025	96	111	34	

NB: Reversible Back Plate

UDINE



▶ Udine				
CODE	C/C	L	W	P
Finish: Matte Chrome 				
147.87006.399	96	128	37	3

* Recess Size

VALLE



▶ Valle				
CODE	C/C	L	W	P
Finish: Satin Chrome 				
582016	102	114	34	2

* Face Fix | Recess Size | Screws Included

KNOBS & HANDLES

TRADITIONAL. Knobs & Handles

RUTLAND





38mm



30mm

▶ Rutland

CODE	KNOB WITH PLATE	D	P	
Finish: Antique Pewter White 				
102.55430.549		30	30	
102.55438.549		38	36	
Finish: Antique Pewter Ivory 				
102.55430.551		30	30	
102.55438.551		38	36	
Finish: Antique Brass White 				
102.55438.553		38	36	

RUTLAND



T-knob







Swivel



Rigid

▶ Rutland

CODE	HANDLES	C/C	L	W	P	DIA
Finish: Antique Pewter White 						
102.55575.549	T-knob		76	25	35	
102.55675.549	T-knob		76	25	46	
103.55710.549	Swivel	160	190	60	24	
103.55712.549	Swivel	224	248	60	24	
103.55806.549	Rigid	96	123	25	41	
103.55809.549	Rigid	128	152	25	38	
103.55811.549	Rigid	192	219	25	39	
Finish: Antique Pewter Ivory 						
102.55675.551	T-knob		76	25	46	
103.55806.551	Rigid	96	123	25	41	
103.55809.551	Rigid	128	152	25	38	
103.55811.551	Rigid	192	249	25	39	
Finish: Antique Brass White 						
102.55675.553	T-knob		76	25	46	
103.55710.553	Swivel	160	190	60	24	
103.55712.553	Swivel	224	248	60	24	
Finish: Antique Brass Ivory 						
102.55675.555	T-knob		76	25	46	
103.55710.555	Swivel	160	190	60	24	

KNOBS & HANDLES

TRADITIONAL. Knobs & Handles

CAGE





Rigid Pull



T-knob



Swivel Bail

► Cage					
CODE	TYPE	C/C	L	W	P
Finish: Burnished Iron 					
125.57062.360	T-Knob	-	62	22	34
126.57406.360	Rigid Pull	96	104	18	36
126.57409.360	Rigid Pull	128	137	18	36
Finish: Gloss Black 					
125.57062.002	T-knob	-	62	22	34
126.57406.002	Rigid Pull	96	104	18	36
126.57109.002	Swivel Bail	128	148	50	23
126.57409.002	Rigid Pull	128	137	18	36



EPOCH



Swivel Bail



Swivel Ring

► Epoch					
CODE		C/C	L	W	P
Finish: Antique Brass 					
141.39603.383	Swivel Bail	64	100	40	20
143.39746.383	Swivel Ring	-	53	46	14
Finish: Satin Black 					
143.39746.402#	Swivel Ring	-	53	46	14

BRUNEL



► Brunel					
CODE		C/C	L	W	P
Finish: Antique Pewter 					
141.35006.417		96	145	18	33

KNOBS & HANDLES

TRADITIONAL. Knobs & Handles

BRIXTON



► Brixton					
CODE		L	W	P	
Finish: Burnished Iron 					
126.27000.360		95	43	20	
Screws Included					

SCALLOPED



► Scalloped					
CODE		L	W	P	
Finish: Satin Black 					
126.08900.358		100	51	20	
Screws Included					

KNOBS & HANDLES

KNOBS. Modern

STELVIO

When the simplest ingredients bring about maximum enjoyment. Artia's new STELVIO knob is an elegant addition to any piece of furniture. Available in all six modern finishes for a wide range of cabinet or furniture pieces.



With its timeless design, it is perfectly suited to combining with Artia's best-selling handles, including the new VANIGLIA range. For example....



VANIGLIA









CERA



ANGOL



LATA

► Stelvio				
CODE	P		D	
Finish: Matt Black 				
102.77730.002	32		30	
Finish: Anthracite 				
102.77730.123	32		30	
Finish: Chrome 				
102.77730.340	32		30	
Finish: Brushed Nickel 				
102.77730.412	32		30	
Finish: Vintage Bronze 				
102.77730.413	32		30	
Finish: Matt Gold 				
102.77730.611	32		30	

KNOBS & HANDLES

KNOBS. Traditional



ORBITA



► Orbita				
CODE	P		D	
Finish: Polished Brass 				
150110	30		40	

STRATFORD



► Stratford				
CODE	P		D	
Finish: Florentine Brass 				
140.10734.382	25		34	
Finish: Pewter 				
140.10734.392	25		34	
Finish: Satin Black 				
140.10734.402	25		34	

VETRO



► Vetro				
CODE	D		P	
Finish: Chrome / Clear Glass 				
055173-1	31		38	

OCTAGONO





► Octagono				
CODE	D		P	
Finish: Chrome / Clear Glass 				
055175-1	35		30	

KNOBS. Modern

CONO C



► Cono C				
CODE	P		D	
Finish: Matte Chrome 				
120.52020.335	24		20	
Finish: Brushed Nickel 				
120.52025.438	30		25	

KNOBS & HANDLES

KNOBS. Traditional

LIVIGNO

With its elegant base and subtle ring on the outer edge, the new LIVIGNO knob is modern yet exudes timeless charm and is available in four finishes.

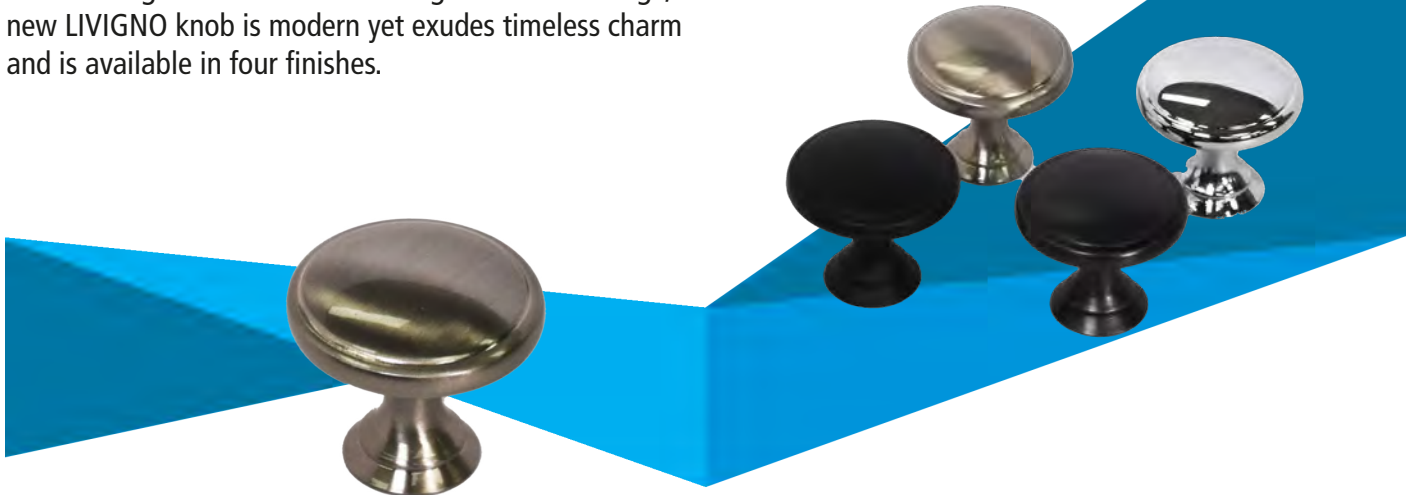





ANGOL



CERA



▶ LIVIGNO				
CODE	P		D	
Finish: Matt Black 				
102.77732.002	32		32	
Finish: Chrome 				
102.77732.340	32		32	
Finish: Brushed Nickel 				
102.77732.412	32		32	
Finish: Vintage Bronze 				
102.77732.413	32		32	





Together with some of Artia's best-selling handles, the LIVIGNO creates a complete handle solution for a classic cabinetry with timeless appeal.

KNOBS & HANDLES

KNOBS. Modern

SEMI



▶ Semi				
CODE	P		D	
Finish: White 				
111.04422.001	30		22	
Finish: Black 				
111.04422.002	30		22	
Finish: Chrome 				
111.04422.387	30		22	
Finish: Brushed Nickel 				
111.04422.412	30		22	

TACCA



▶ Tacca				
CODE	P		D	
Finish: Satin Aluminium 				
110.33125.306#	30		25	
Finish: Satin Black 				
110.33320.307	26		20	
Finish: Brushed Nickel 				
110.33315.412	22		15	
110.33120.412# (110.33320.412)	26		20	

SEGNI



▶ Segni				
CODE	C/C	L	w	p
Finish: Matte Nickel 				
141.40028.394#	16	26	14	23

TOURS



▶ Tours				
CODE	P		D	
Finish: Brushed Nickel 				
140.00232.412	30		32	
140.00238.412	36		38	

KNOBS & HANDLES

KNOBS. Modern



BECKETT



▶ Beckett				
CODE	P		D	
Finish: Brushed Nickel (.438) 				
130.49232.438	31		32	
130.49328.438	32		38	

MANSELL



▶ Mansell				
CODE	P		D	
Finish: Chrome 				
140.31430.387	28		30	
Finish: Matte Chrome 				
140.31430.395	28		30	

MONTOYA



▶ Montoya				
CODE	P		D	
Finish: Brushed Nickel 				
140.16125.412	25		25	

KNOBS & HANDLES

INDEX PART NUMBERS

Part Number.....	Page
102.55430.549	24
102.55430.551	24
102.55438.549	24
102.55438.551	24
102.55438.553	24
102.55575.549	24
102.55675.549	24
102.55675.551	24
102.55675.553	24
102.55675.555	24
102.77730.002	27
102.77730.123	27
102.77730.340	27
102.77730.412	27
102.77730.413	27
102.77730.611	27
102.77732.002	29
102.77732.340	29
102.77732.412	29
102.77732.413	29
103.55710.549	24
103.55710.553	24
103.55710.555	24
103.55712.549	24
103.55712.553	24
103.55806.549	24
103.55806.551	24
103.55809.549	24
103.55809.551	24
103.55811.549	24
103.55811.551	24
110.33320.412	30
110.33120.412#	30
110.33125.306#	30
110.33315.412	30
110.33320.307	30
111.02306.002	10
111.02306.412	10
111.02306.611	10
111.02309.002	10
111.02309.412	10
111.02310.002	10
111.02310.412	10
111.02310.611	10
111.02312.002	10
111.02312.412	10
111.02313.002	10
111.02313.412	10
111.02313.611	10
111.02315.002	10
111.02315.412	10
111.04422.001	30
111.04422.002	30

Part Number.....	Page
111.04422.387	30
111.04422.412	30
111.07506.412	12
111.07509.412	12
111.07510.412	12
111.07512.412	12
111.07515.412	12
111.20009.412	11
111.20010.412	11
111.20013.412	11
111.20015.412	11
111.31106.412	21
111.31110.412	21
111.31115.412	21
111.31199.301	21
111.33031.001	22
111.33031.412	22
111.33031.002	22
111.33100.387	22
111.33101.001	22
111.33101.002	22
111.33101.412	22
111.33120.412#	30
111.33201.001	22
111.33201.002	22
111.33201.412	22
111.33301.001	22
111.33301.002	22
111.33301.412	22
111.33501.001	22
111.33501.002	22
111.33501.412	22
111.70206.002	05
111.70206.123	05
111.70206.412	05
111.70206.611	05
111.70209.002	05
111.70209.123	05
111.70209.412	05
111.70210.002	05
111.70210.123	05
111.70210.412	05
111.70210.611	05
111.70213.002	05
111.70213.123	05
111.70213.412	05
111.70213.611	05
111.70215.002	05
111.70215.123	05
111.70215.412	05
111.70506.002	06
111.70506.340	06
111.70506.412	06

KNOBS & HANDLES

INDEX PART NUMBERS

Part Number.....	Page	Part Number.....	Page
111.70506.413	06	111.71615.412	08
111.70509.002	06	111.71615.413	08
111.70509.340	06	111.71709.002	07
111.70509.412	06	111.71709.340	07
111.70509.413	06	111.71709.412	07
111.70510.002	06	111.71709.413	07
111.70510.340	06	111.71710.002	07
111.70510.412	06	111.71710.340	07
111.70510.413	06	111.71710.412	07
111.70513.002	06	111.71710.413	07
111.70513.340	06	111.71713.340	07
111.70513.412	06	111.71713.412	07
111.70513.413	06	111.71713.413	07
111.70515.002	06	111.71713.002	07
111.70515.340	06	111.71715.002	07
111.70515.412	06	111.71715.412	07
111.70515.413	06	111.71715.413	07
111.70606.002	09	111.78510.412#	15
111.70606.340	09	116.33200.320	22
111.70606.412	09	116.33336.320	22
111.70606.413	09	116.33379.320	22
111.70609.002	09	116.80010.316	12
111.70609.340	09	116.80014.316	12
111.70609.412	09	116.81209.316	12
111.70609.413	09	116.81210.316	12
111.70610.002	09	116.81211.316	12
111.70610.340	09	116.81214.316	12
111.70610.412	09	116.86006.320	17
111.70610.413	09	116.86009.320	17
111.70613.002	09	116.86010.320	17
111.70613.340	09	116.86011.320	17
111.70613.412	09	116.86014.320	17
111.70613.413	09	116.86016.320	17
111.70615.002	09	116.86020.320	17
111.70615.340	09	120.52020.335	28
111.70615.412	09	120.52025.438	28
111.70615.413	09	121.22406.336	19
111.71606.002	08	121.22409.336	19
111.71606.412	08	121.22410.336	19
111.71606.413	08	121.26006.336	17
111.71609.002	08	121.26006.340	17
111.71609.340	08	121.26009.336	17
111.71609.412	08	121.26009.340	17
111.71609.413	08	121.26010.336	17
111.71610.002	08	121.26011.336	17
111.71610.340	08	121.26012.336	17
111.71610.412	08	121.26014.336	17
111.71610.413	08	121.26015.336	17
111.71613.002	08	121.26018.336	17
111.71613.340	08	121.26019.336#	17
111.71613.412	08	125.57062.002	25
111.71613.413	08	125.57062.360	25
111.71615.002	08	126.08900.358	26

KNOBS & HANDLES

INDEX PART NUMBERS

Part Number.....	Page
126.27000.360	26
126.57109.002	25
126.57406.002	25
126.57406.360	25
126.57409.002	25
126.57409.360	25
130.49232.438	31
130.49328.438	31
131.39680.423	21
131.39680.431	21
131.39680.432	21
131.39680.438	21
140.00232.412	30
140.00238.412	30
140.10734.382	28
140.10734.392	28
140.10734.402	28
140.16125.412	31
140.31430.387	31
140.31430.395	31
141.02309.387	10
141.02309.395	10
141.02309.412	10
141.02311.387	10
141.02311.395	10
141.02311.412	10
141.02313.387	10
141.02313.412	10
141.02315.412	10
141.22606.412	16
141.22609.412	16
141.26806.412#	17
141.26810.412#	17
141.27306.412-1	14
141.27309.412-1	14
141.35006.417	25
141.39603.383	25
141.40028.394#	30
141.45906.402#	15
141.59306.387	13
141.59306.395	13
141.59306.002	13
141.59306.412	13
141.59309.387	13
141.59309.395	13
141.59309.002	13
141.59309.412	13
141.59310.387	13
141.59310.395	13
141.59310.002	13
141.59310.412	13
141.59312.387	13
141.59312.395	13

Part Number.....	Page
141.59312.002	13
141.59312.412	13
141.59314.387	13
141.59314.395	13
141.59314.002	13
141.59314.412	13
141.59315.412	13
141.59316.412	13
141.59319.412	13
141.66801.394	21
141.79009.412	18
141.79010.412	18
141.79011.412	18
141.79012.412	18
141.79013.412	18
141.79014.412	18
141.79015.412	18
141.79016.412	18
141.79018.412	18
141.79066.412	18
141.80606.412	18
141.80609.412	18
141.80610.412	18
141.80613.412	18
141.80615.412	18
141.85906.412	16
141.85909.412	16
141.90510.412	16
141.90512.387	16
141.90512.412	16
143.39746.383	25
143.39746.402#	25
143.98901.395	20
143.98903.395	20
147.87006.399	23
161.08684.088	20
161.20106.001	20
161.20106.002	20
161.20306.001	20
11937.032.002	04
11937.032.412	04
11937.076.002	04
11937.076.412	04
11937.128.002	04
11937.128.412	04
054271	19
054272	19
054275	19
054281	19
054282	19
054291	19
054292	19
054295	19
054296	19

KNOBS & HANDLES

INDEX PART NUMBERS

Part Number.....	Page	Part Number.....	Page
054335	18	055846	14
054336	18	055847	14
054337	18	055848	14
054394	16	055849	14
054395-1	16	055850	14
054484	14	055851	14
054485	14	055852	14
054486	14	055853#	14
054487	14	055854	14
054488	14	055873#	11
054489	14	055875#	11
054749	19	150110	28
054750	19	185250	23
054752	19	290795	15
054753	19	290796	15
054767	23	290798	15
054768	23	290800	15
054770	23	290802	15
054842	14	582016	23
055001#	11		
055003#	11		
055025	23		
055132	11		
055134	11		
055136	11		
055142	11		
055146	11		
055156	15		
055160	15		
055173-1	28		
055175-1	28		
055472	12		
055473	12		
055474	12		
055475	12		
055476	12		
055477	12		
055479	12		
055481	12		
055483	12		
055695	16		
055696-1	16		
055696#	16		
055698-1	16		
055699-1	16		
055700	16		
055702	16		
055704-1	16		
055705	16		
055706-1	16		
055843	14		
055844	14		
055845	14		



CABINET HARDWARE SYSTEMS

KNOBBS & HANDLES

#KAH2.0

Australia

1800 008 591 ■ www.artia.com.au

VICTORIA:

235 Settlement Road,
Thomastown VIC 3074

NEW SOUTH WALES:

6 Nello Place
Wetherill Park NSW 2164

QUEENSLAND:

Building 2/660 MacArthur
Avenue, Pinkenba QLD 4008

SOUTH AUSTRALIA:

13 Rosberg Road,
Wingfield SA 5013

WESTERN AUSTRALIA:

Unit 5/1 Dellamarta Road,
Wangara WA 6065

New Zealand

0800 267 625 ■ www.artia.co.nz

AUCKLAND:

11 Bruce Roderick Drive,
East Tamaki, Auckland 2013

CHRISTCHURCH:

117 Wrights Road,
Addington, Christchurch 8024